





 **SCHONBEK** | 1870











OLDE WORLD 6807E- __ __ H





-  x 2
-  : 15cm
-  : 37cm
-  : 41cm
-  : 2kg

THIS DESIGN IS THE PROPRIETARY TRADE DRESS/TRADEMARK OF W SCHONBEK LLC.

 **SCHONBEK** | 1870

								
2 X MAX 40 W		220-240 V						

- 1 X  : 432
- 1 X  : 190/1-**
- 1 X  : 1022/1-**

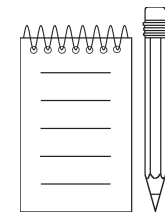
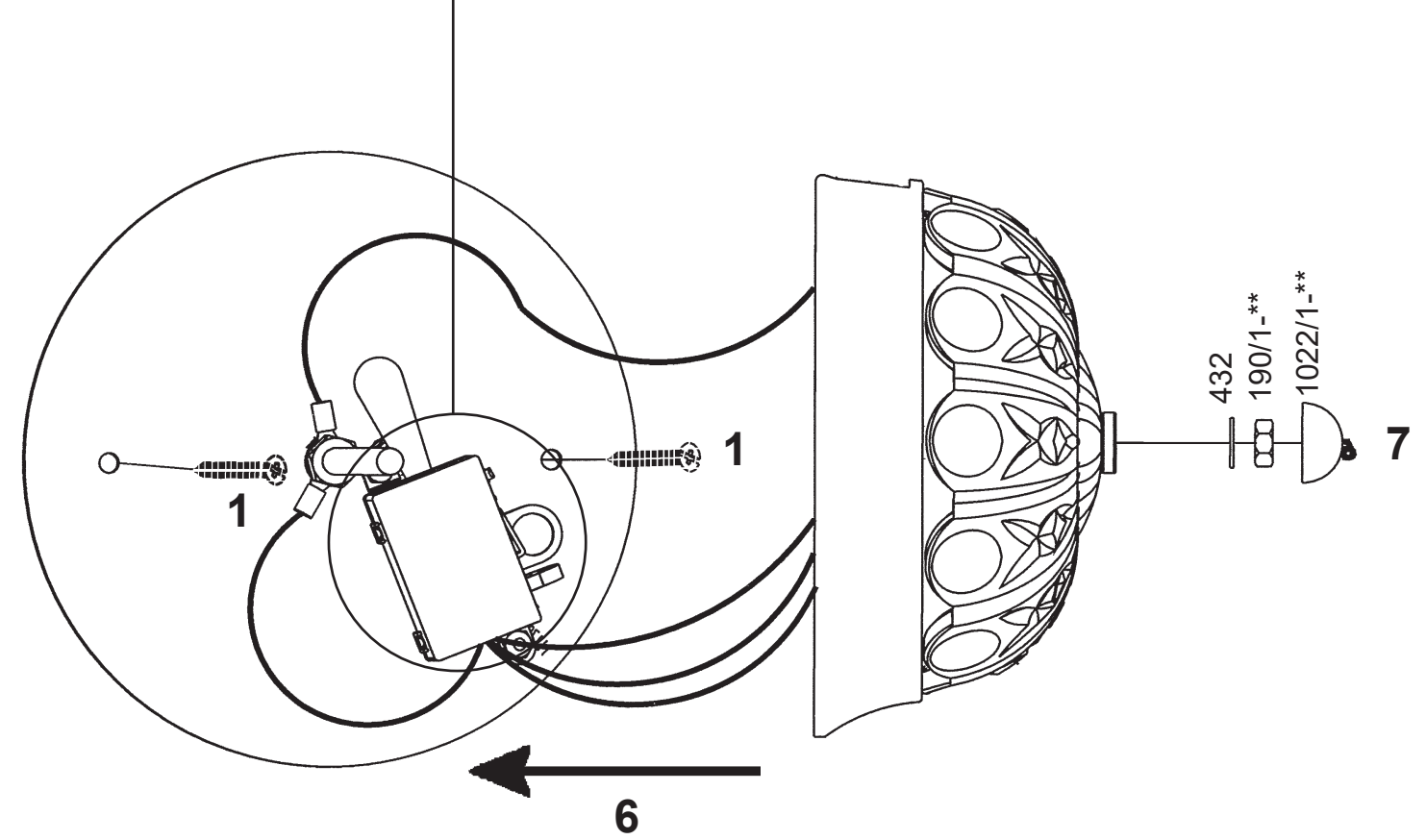
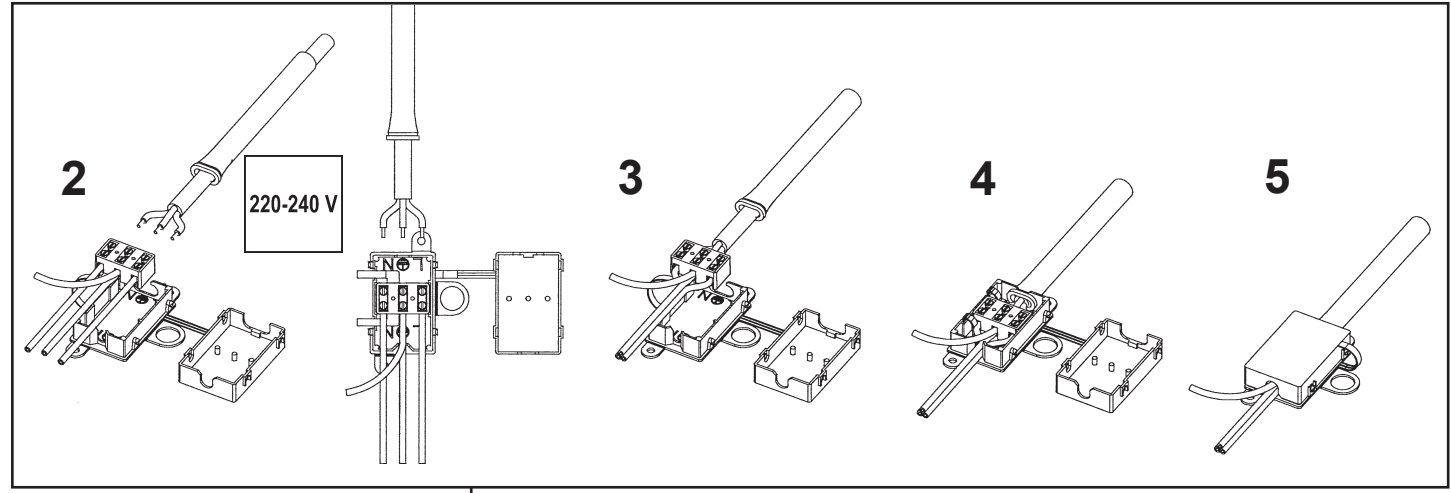

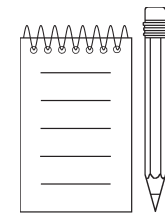



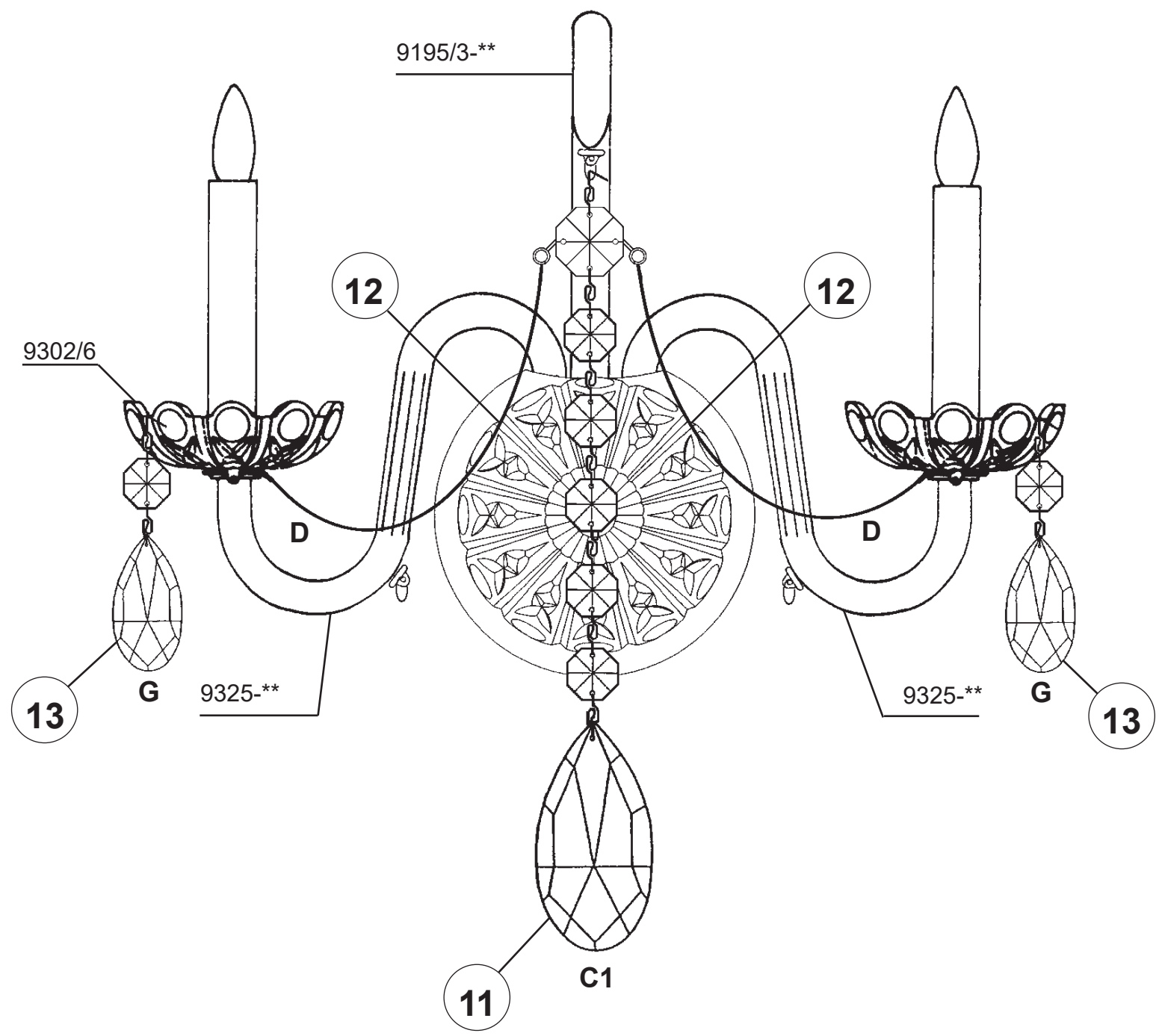
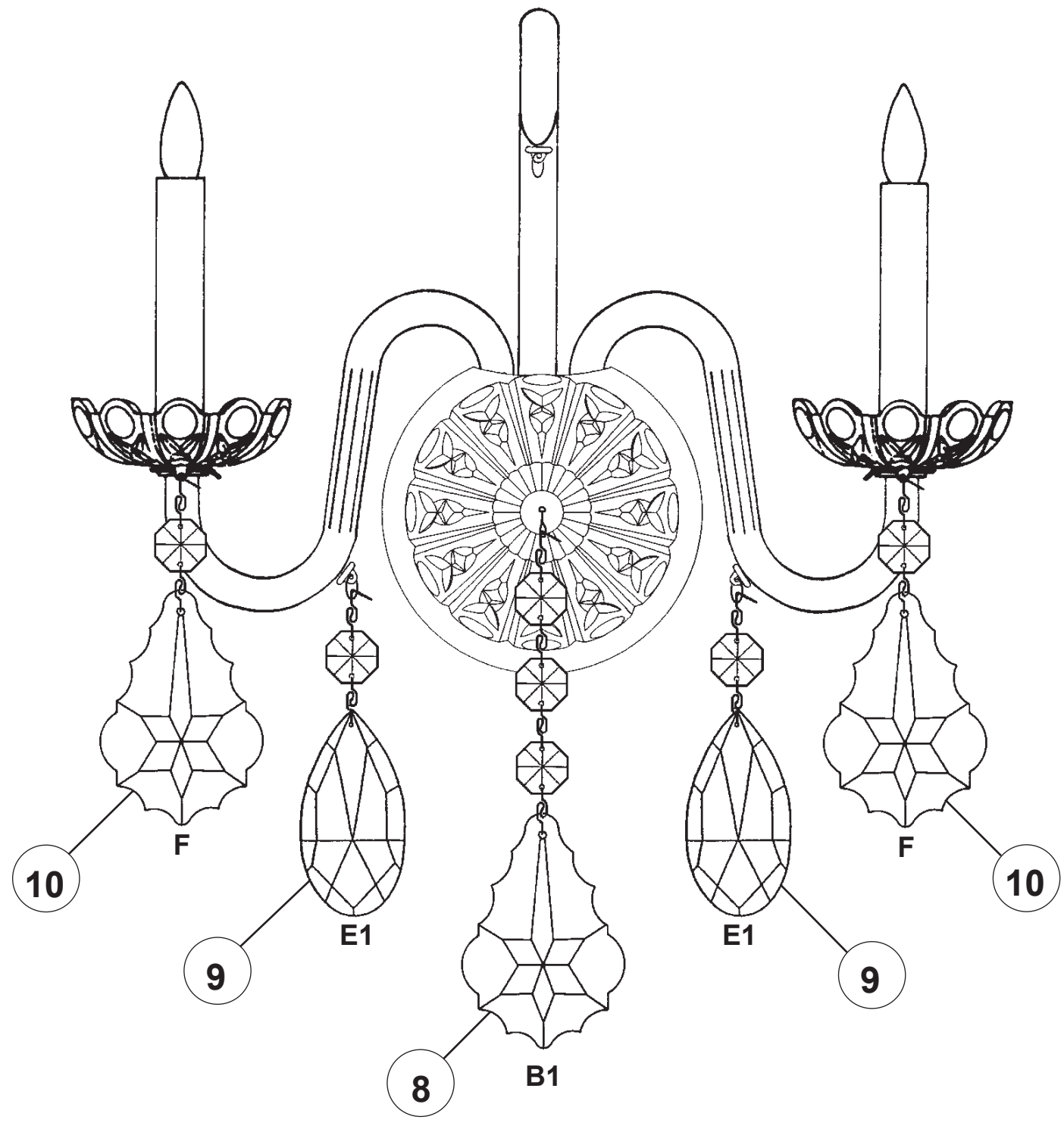

2 X  : E14 40W MAX



 **SCHONBEK** | 1870











OLDE WORLD 6807E- __ __ R





-  x 2
-  : 15cm
-  : 37cm
-  : 41cm
-  : 2kg

THIS DESIGN IS THE PROPRIETARY TRADE DRESS/TRADEMARK OF W SCHONBEK LLC.

 **SCHONBEK** | 1870

								
2 X MAX 40 W		220-240 V						

- 1 X  : 432
- 1 X  : 190/1-**
- 1 X  : 1022/1-**

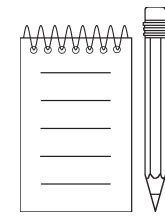
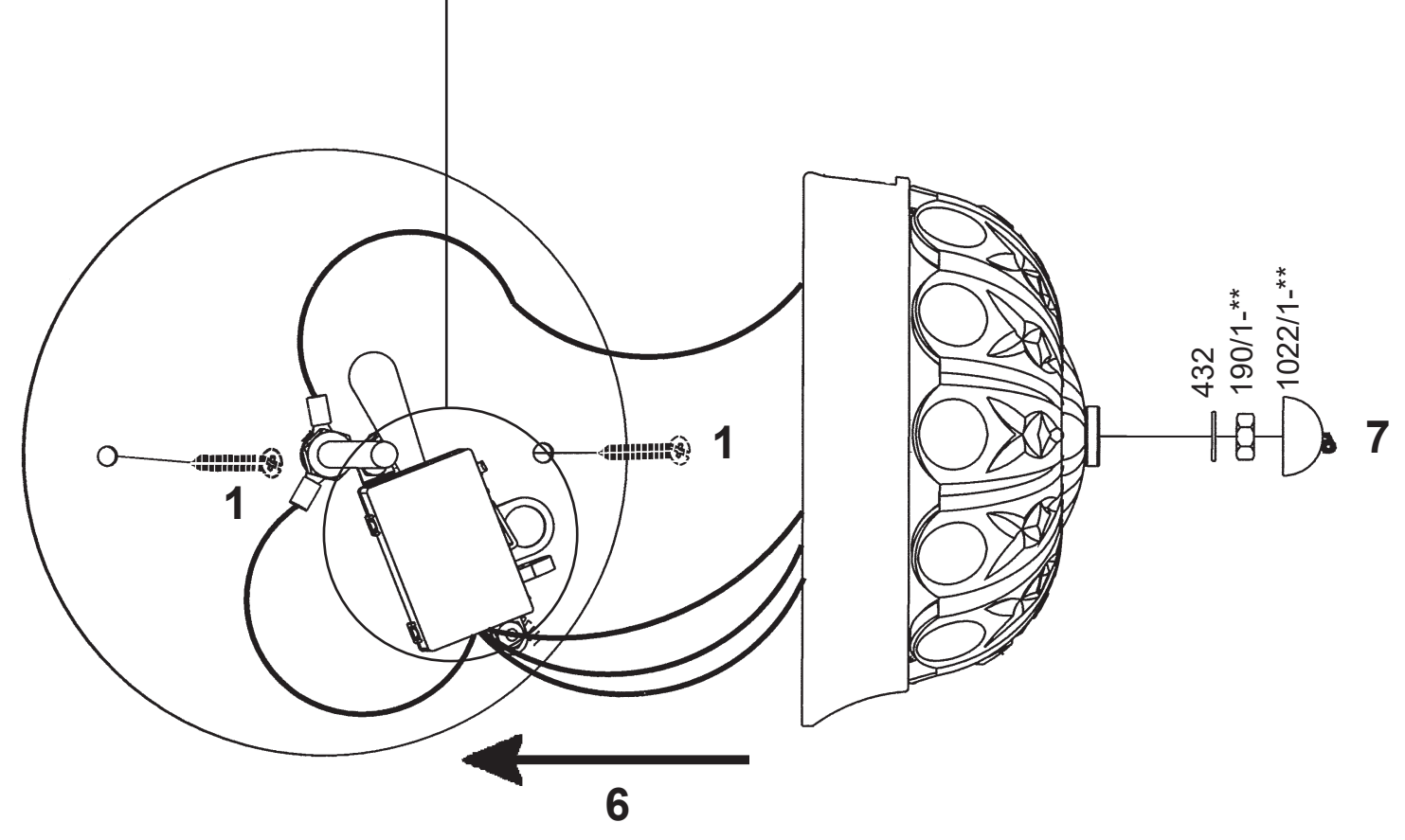
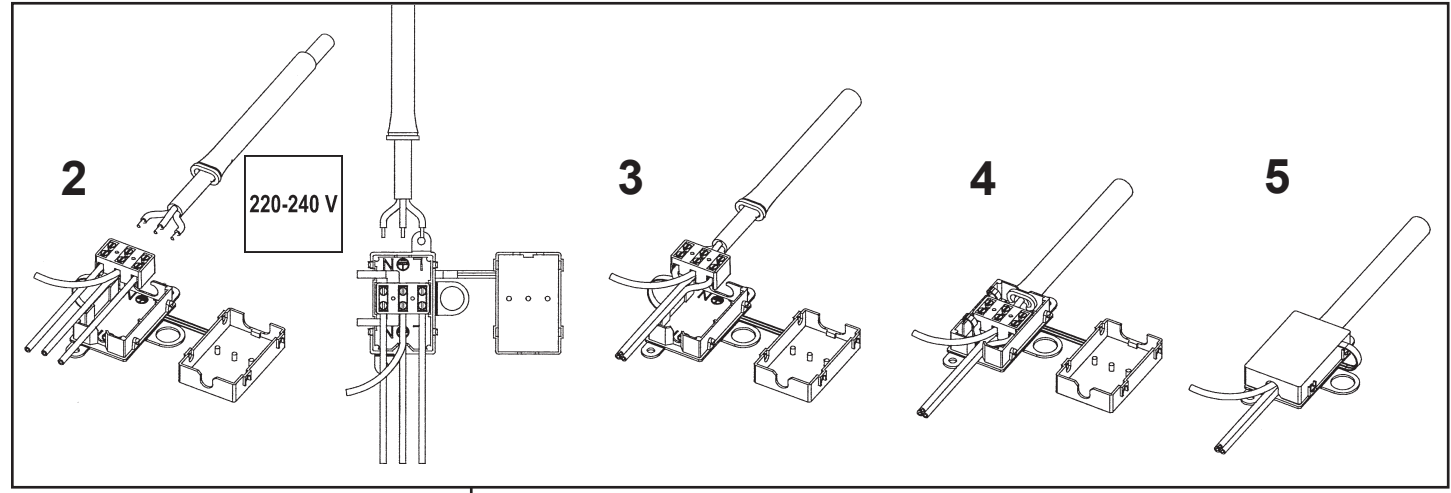

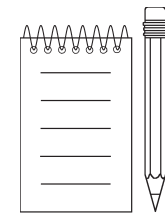
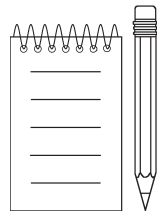

2 X  : E14 40W MAX

