



**ASSEMBLY & INSTALLATION INSTRUCTIONS**



Fixture  
BPD40629

Fig. 2 Wiring

	<b>Fixture Wires</b> Black or Smooth	<b>House Wires</b> Black (Live)
	<b>Fixture Wires</b> White or Ribbed	<b>House Wires</b> White (Neutral)
	<b>Fixture Wires</b> Bare wire (Ground)	<b>House Wires</b> Green or Bare Copper (Ground)

Mounting BackPlate Dimensions

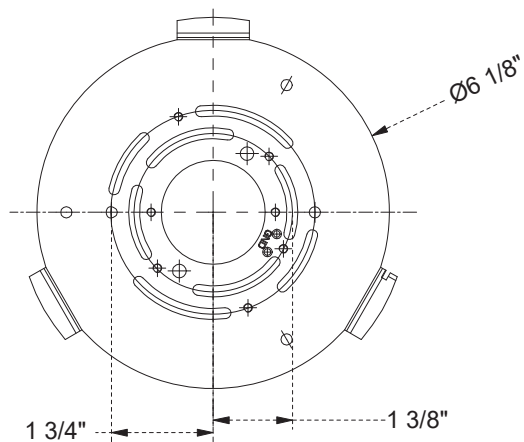
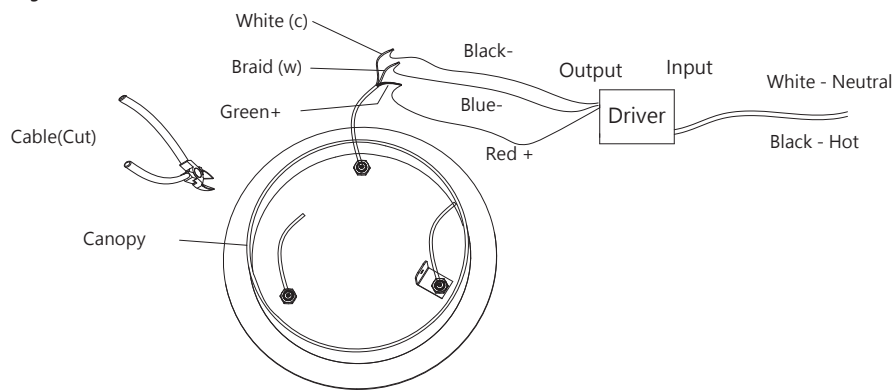

Fig. 3



Schonbek, 61 Industrial Blvd, Plattsburgh, New York, 12901  
Phone: 1-800-836-1892 | Fax: 518-563-4228 |  
[www.schonbek.com](http://www.schonbek.com)

**HARDWARE**

**A**



Wire Connectors  
Qty:3PCS+1Extra

**B**



Mounting screw  
Qty:1Extra

**C**



Anchor Screw  
Qty:3PCS+1Extra

**D**



Plastic Anchor  
Qty:3PCS+1Extra

## ASSEMBLY & INSTALLATION INSTRUCTIONS

Fixture  
BPD40629

SCHONBEK  
*Beyond*

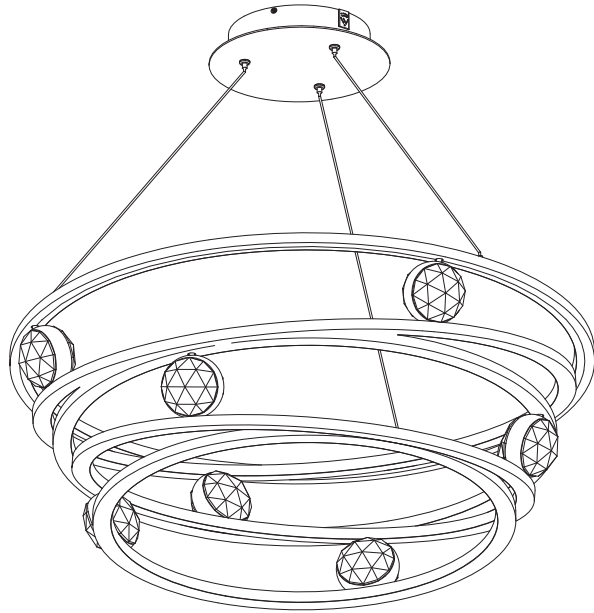

### WARNING

- IMPORTANT: NEVER attempt any work without shutting off the electricity.
- Read all instructions before installing.
  - System is intended for installation in accordance with the National Electrical Code (NEC), other applicable installation code(s) and local regulations by a licensed electrician familiar with the operation of the product and the hazards involved.
  - Go to the main fuse box, or circuit breaker panel. Place the main power switch in the "OFF" position and unscrew the fuse (s) or switch "OFF" the circuit breaker switch (es) that control the power to the fixture (s) or room that you are working on.
  - Place the wall switch in the "OFF" position.
  - FAILURE TO INSTALL THIS FIXTURE IN ACCORDANCE WITH THESE INSTRUCTIONS MAY RESULT IN SERIOUS PERSONAL INJURY OR DEATH AND/OR PROPERTY DAMAGE.

### CAUTION

- All parts must be used as indicated in these instructions. Do not substitute any parts, leave parts out, or use any parts that are worn out or broken. Failure to follow this instruction could invalidate the ETL/CETL Listing of this fixture.
- When handling the fixture, do not apply pressure to the LEDs or bulbs. Hold the fixture by the base only.
- Do not exceed maximum wattage noted on the fixture. Use only the recommended LED or standard lamps with the fixture.

### ADVERTENCIA

- IMPORTANTE: NUNCA trate de hacer ningún trabajo sin desconectar la electricidad.
- Lea todas las instrucciones antes de instalar.
  - El sistema tiene por objeto la instalación de acuerdo con el Código Eléctrico Nacional, y otros códigos de instalación y reglamentos locales aplicables, por parte de un electricista autorizado que esté familiarizado con el funcionamiento del producto y los peligros involucrados.
  - Vaya a la caja de fusibles o al panel de disyuntores principal. Ponga el interruptor principal de alimentación en la posición de "APAGADO", y desconecte los fusibles o "DESCONECTE" los disyuntores que controlen la alimentación a los dispositivos o la habitación en los que usted está trabajando.
  - Ponga el interruptor de pared en la posición de "APAGADO".
  - EL HECHO DE NO INSTALAR ESTE DISPOSITIVO DE ACUERDO CON ESTAS INSTRUCCIONES PODRÍA RESULTAR EN UNA LESIÓN PERSONAL GRAVE O LA MUERTE, Y/O DAÑOS A LA PROPIEDAD.

### PRECAUCIÓN

- Todas las piezas deben usarse como se indica en estas instrucciones. No sustituya ninguna pieza, no deje piezas fuera, ni utilice ninguna pieza que esté desgastada ni rota. El hecho de no seguir estas instrucciones podría invalidar la certificación ETL/CETL de este dispositivo.
- Al manipular el dispositivo, no aplique presión a los LED ni las bombillas. Sujete el dispositivo solo por la base.
  - No exceda la potencia máxima indicada en el dispositivo. Use solo los LED o las bombillas estándar recomendados con el dispositivo.

### ADVERTENCIA

- IMPORTANT: NUNCA trate de hacer ningún trabajo sin desconectar la electricidad. IMPORTANT: Ne JAMAIS entreprendre des travaux sans couper l'électricité.
- Lire toutes les instructions avant l'installation.
  - Ce système est conçu pour être installé conformément au Code national de l'électricité ou d'autres codes d'installation et réglementations locales en vigueur par un électricien agréé connaissant le fonctionnement de ce produit et les dangers qu'il comporte.
  - Aller à la boîte à fusibles ou panneau principal de disjoncteurs. Placer l'interrupteur d'alimentation principal sur « ARRÊT » et dévisser le ou les fusibles ou mettre sur « ARRÊT » le ou les disjoncteurs qui contrôlent l'alimentation du ou des appareils électriques ou de la pièce dans laquelle vous travaillez.
  - Mettre l'interrupteur mural sur « ARRÊT ».
  - NÉGLIGER D'INSTALLER CET APPAREIL CONFORMÉMENT À CES INSTRUCTIONS RISQUE D'ENTRAÎNER DE GRAVES BLESSURES PERSONNELLES OU LA MORT AINSI QUE DES DOMMAGES MATÉRIELS.
  - MISE EN GARDE
  - Toutes les pièces doivent être utilisées comme indiqué dans ces instructions. Ne remplacer aucune pièce, ne laisser aucune pièce de côté ou n'utiliser aucune pièce usée ou cassée. Le non-respect de cette directive peut invalider l'homologation ETL/CETL de cet appareil.
  - Lors de la manipulation de cet appareil, n'appliquer aucune pression sur les DEL ou les ampoules. Maintenir l'appareil par la base uniquement.
  - Ne pas dépasser le nombre de watts maximum indiqué sur l'appareil. N'utiliser que les DEL ou ampoules standard recommandées dans cet appareil.

## ASSEMBLY & INSTALLATION INSTRUCTIONS

Fixture  
BPD40629

SCHONBEK  
*Beyond*

Fig. 1

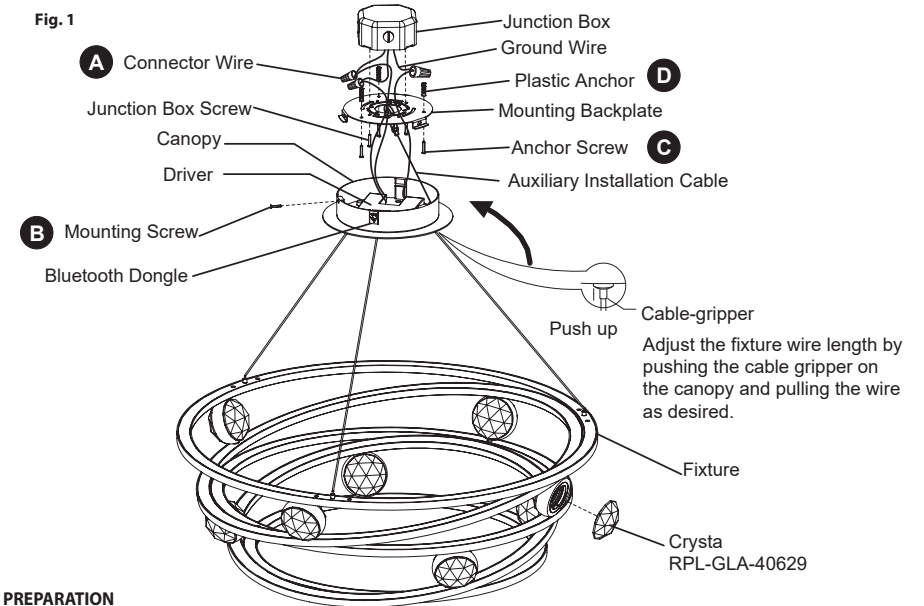

### PREPARATION

- Shut off the power at the circuit breaker and remove existing fixture, including the crossbar.
- Carefully unpack your new fixture and lay out all the parts on a clear area. Be careful not to lose any small parts necessary for installation.
- Use gloves when handling trim, crystals, and acrylic glass components during installation.

### MOUNTING THE FIXTURE (Fig. 1/3)

- Remove the mounting screw (B) from the fixture.
- Drill holes in the ceiling aligned with the key holes located in the back plate, insert the plastic anchor (D)
- Adjust the fixture wire length by pushing the cable gripper on the canopy and pulling the wire as desired.
  - (i) Retract these wires close to a desirable length to within the canopy before securing the fixture in place. Using the cable gripper to adjust more than 18" of wire length is not desirable.
  - (ii) Warning: Shortening these cables without professional help or electronic background is not advisable. Any modifications to the fixture will result in voiding the warranty of the product.
- First, secure the mounting plate to the junction box using the junction box screws. Second, fasten the ceiling plate to the wall using anchor screws (C)

Note: (i) It is recommended to use only original junction box screws or replacements provided by junction box manufacturer.

(ii) The side of the wall plate marked "GND" must face out, towards the installer.

### CONNECTING THE WIRES (Fig. 2/3)

- Secure the auxiliary installation cable to the bracket on the mounting backplate to hang the fixture temporarily in place and aid in installation. Connect the driver input/output wires with junction box wires as shown in Fig.3, making sure that all wire connectors (A) are secured. If your outlet box has a green or bare copper ground wire, connect the fixture's ground wire to it. Otherwise, connect the fixture's ground wire directly to the mounting plate using the green screw provided. After wires are connected, tuck them carefully inside the junction box.
- Secure the fixture by mounting the canopy to the ring of the backplate. Turn and rotate the canopy until it stops. Fasten the canopy to the back plate using the mounting screw (B).

Note: After all input/output wiring and light pole length adjustment after the lighting test is completed. Screw the spare crystal (RPL-GLA-40629) into the lamp holder.