

SCHONBEK
Signature[™]

PERSEPHONE
S78606- __ __ R



THIS DESIGN IS THE PROPRIETARY
TRADE DRESS/TRADEMARK OF
W SCHONBEK LLC.

SCHONBEK
Signature[™]

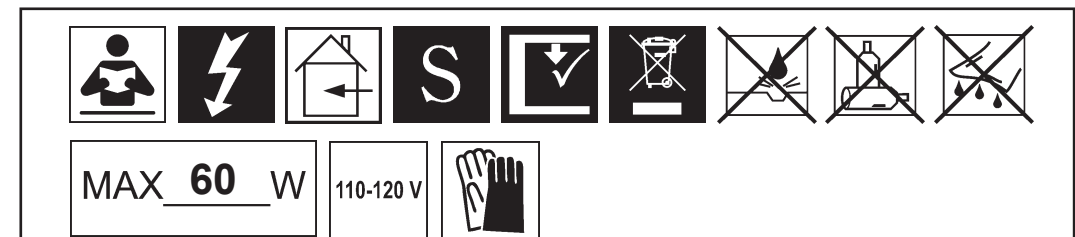

WARNING:

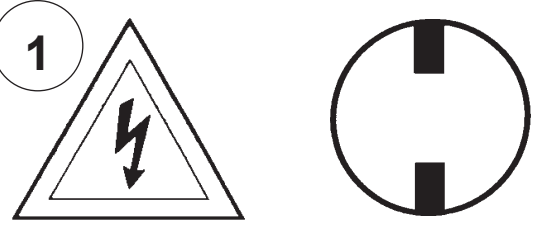
1 

Electrical Danger Turn Power Off

All electrical components must be installed by a licensed electrician in accordance with the National Electric Code and the appropriate local electrical codes.

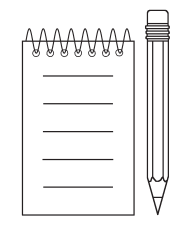
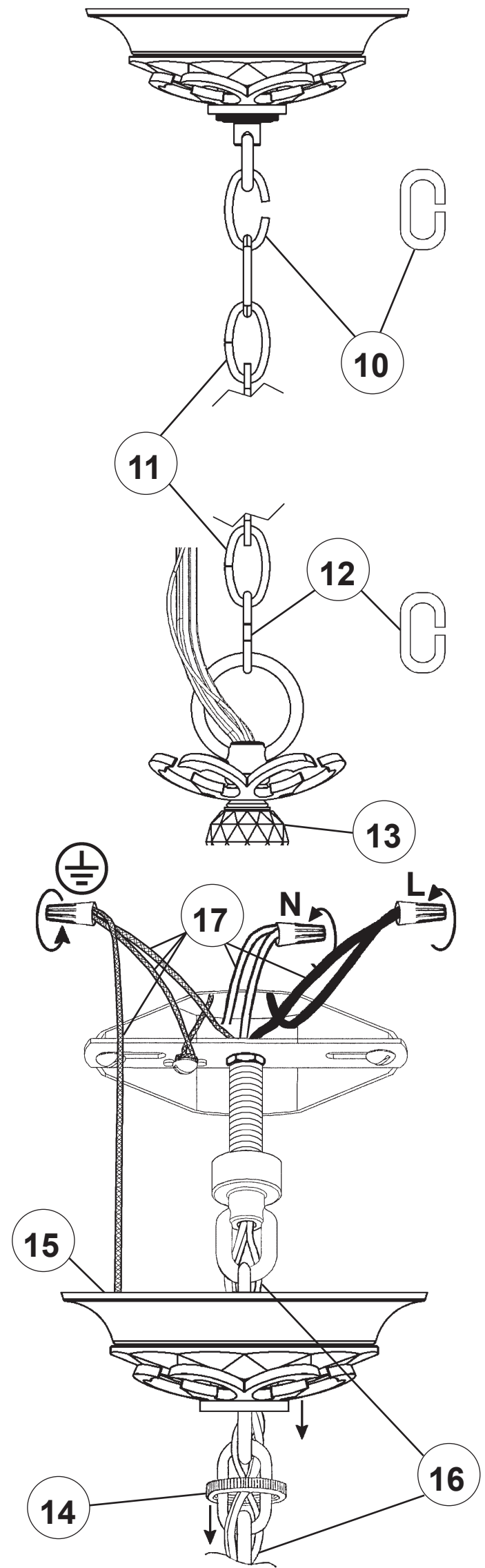
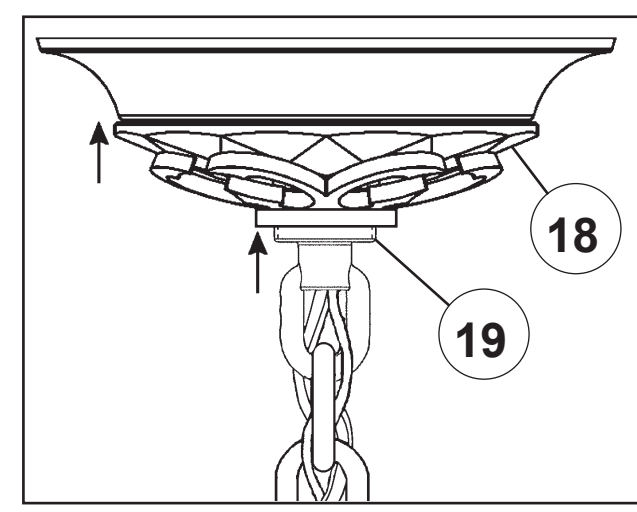
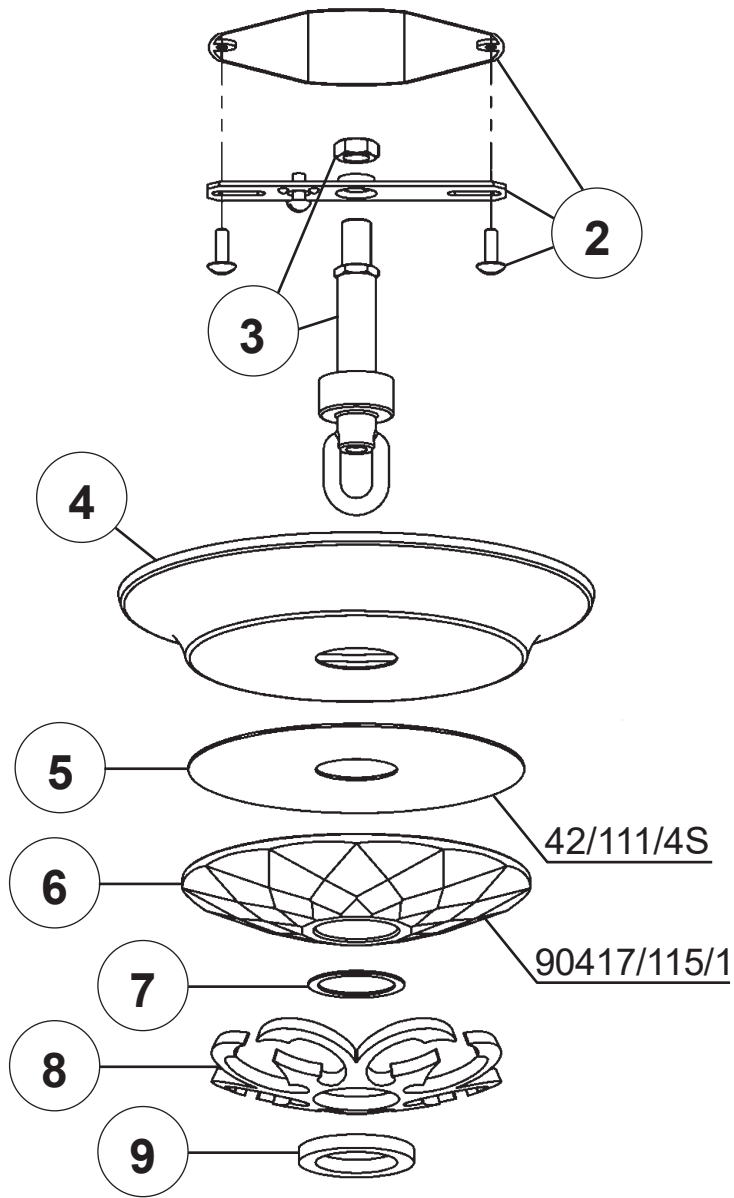

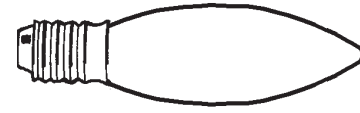
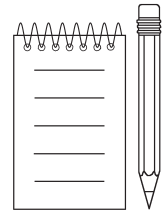

You will need 6 - B10
25 Watts Recommended
60 Watts Max

